

NB. 2 Stk. efter optrukke  
 Limier til Ordre N: 41800.

1 Stk. efter optrukke Limier. til 39700.  
 1 " " stiplede " " "

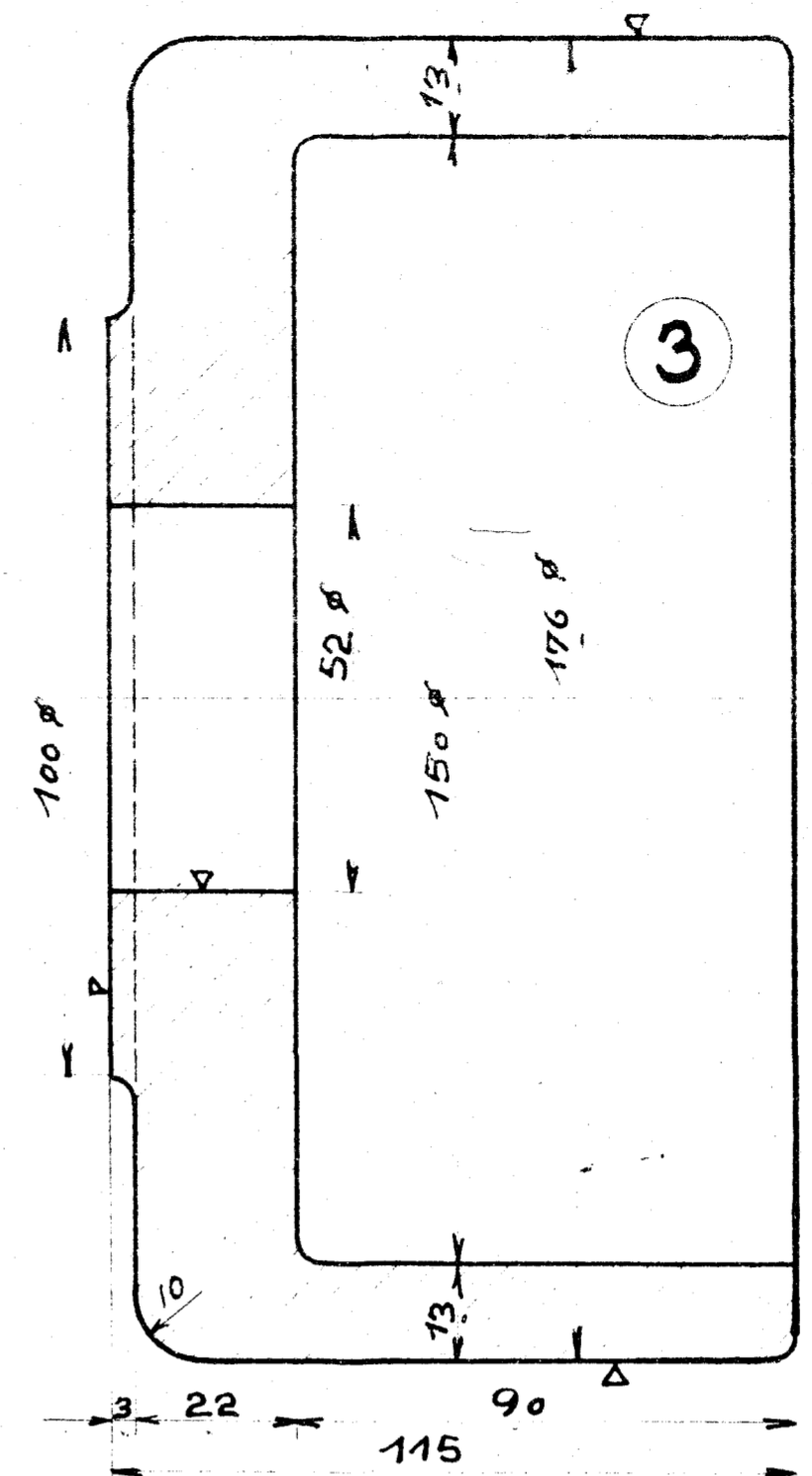
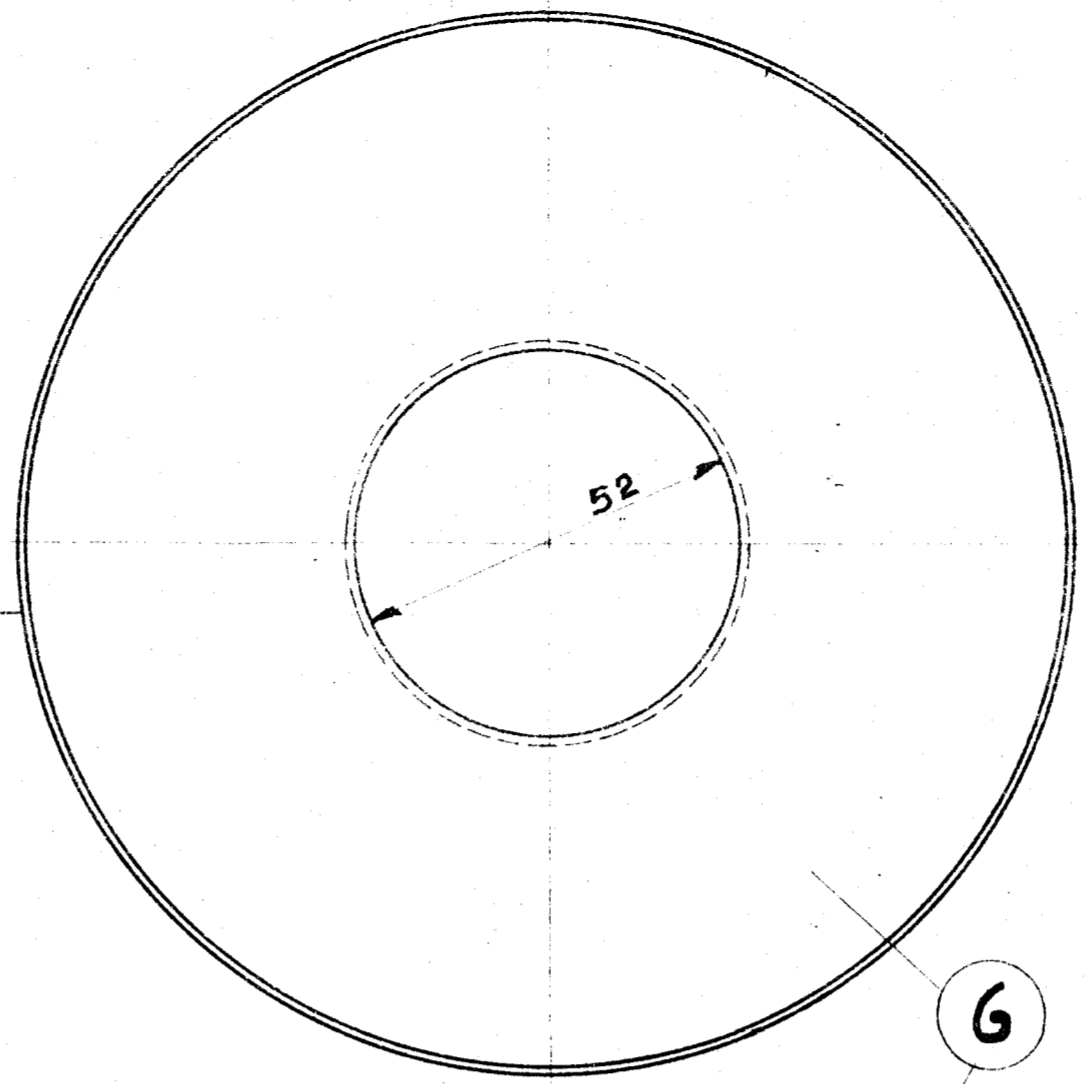

40134

1	2	Trykplade	Fluss	jern	1000	1000
2	2	Afstivningsplade	Fluss	jern	1000	1000
3	2	Styr til Trækkrog	Staal	gods	1000	1000
4	2	Fjederhus til do	Fluss	jern	1000	1000
5	2	Underlag	Fluss	jern	1000	1000
6	28	Fjederkiver	Fjeder	Staal	Best.	Best.
7	4	Bolt 4516	Tran	106 L 52 S 51 A 1	4050	1000
8	2	1/2 150	"	"	"	"
9	2	1/2 140	"	"	"	"

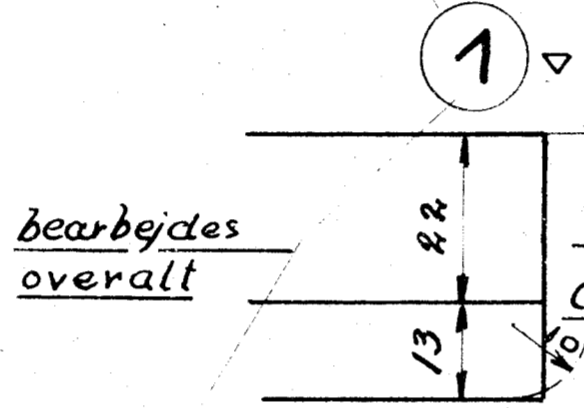
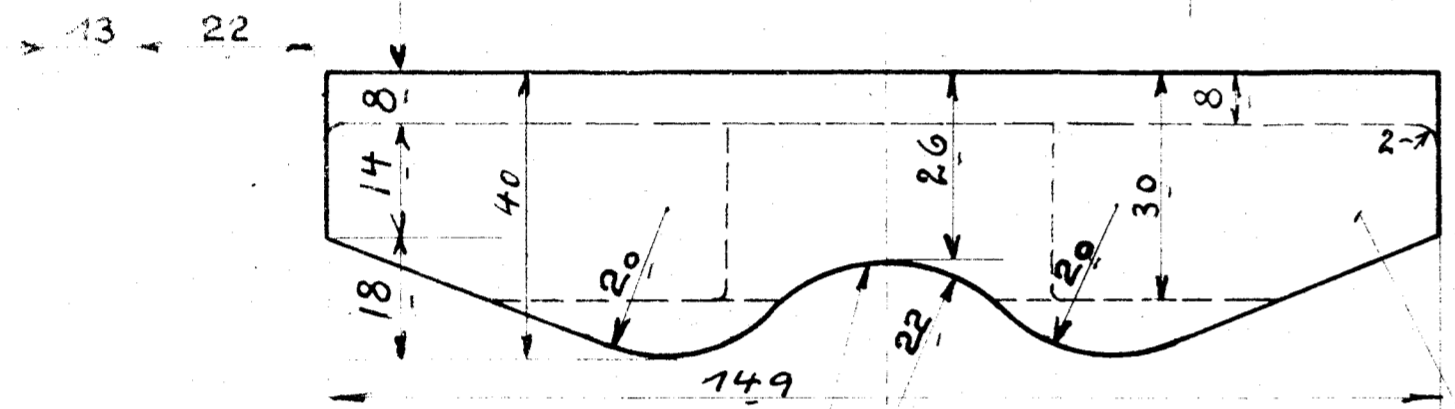

bearbejdes overalt  
 Afrundes kun i den ene Ende af den firkantede Trykplade.

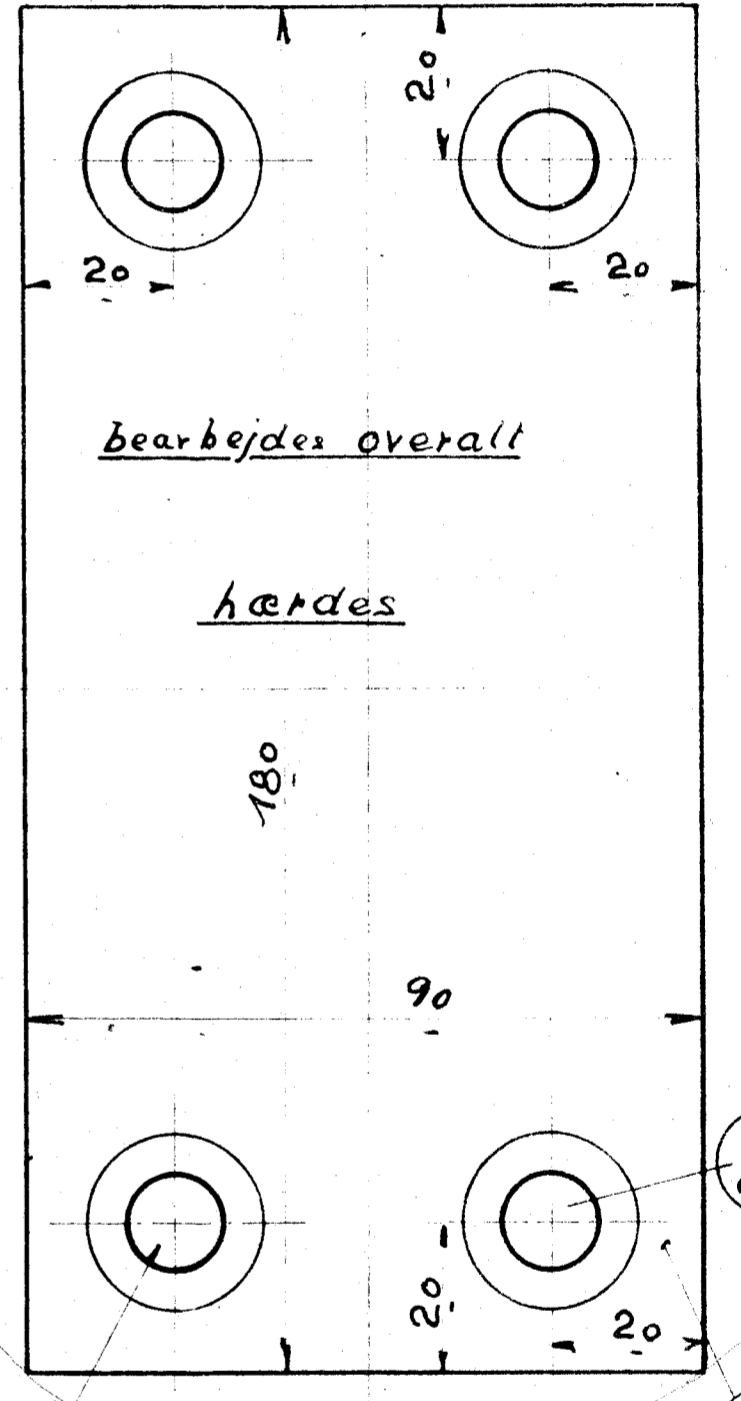

bearbejdes overalt

hærdes

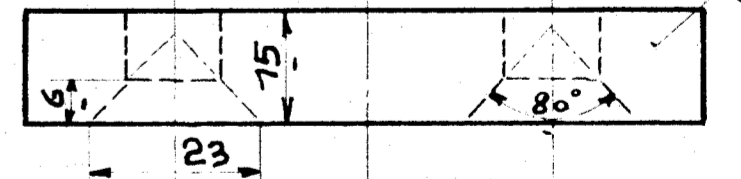
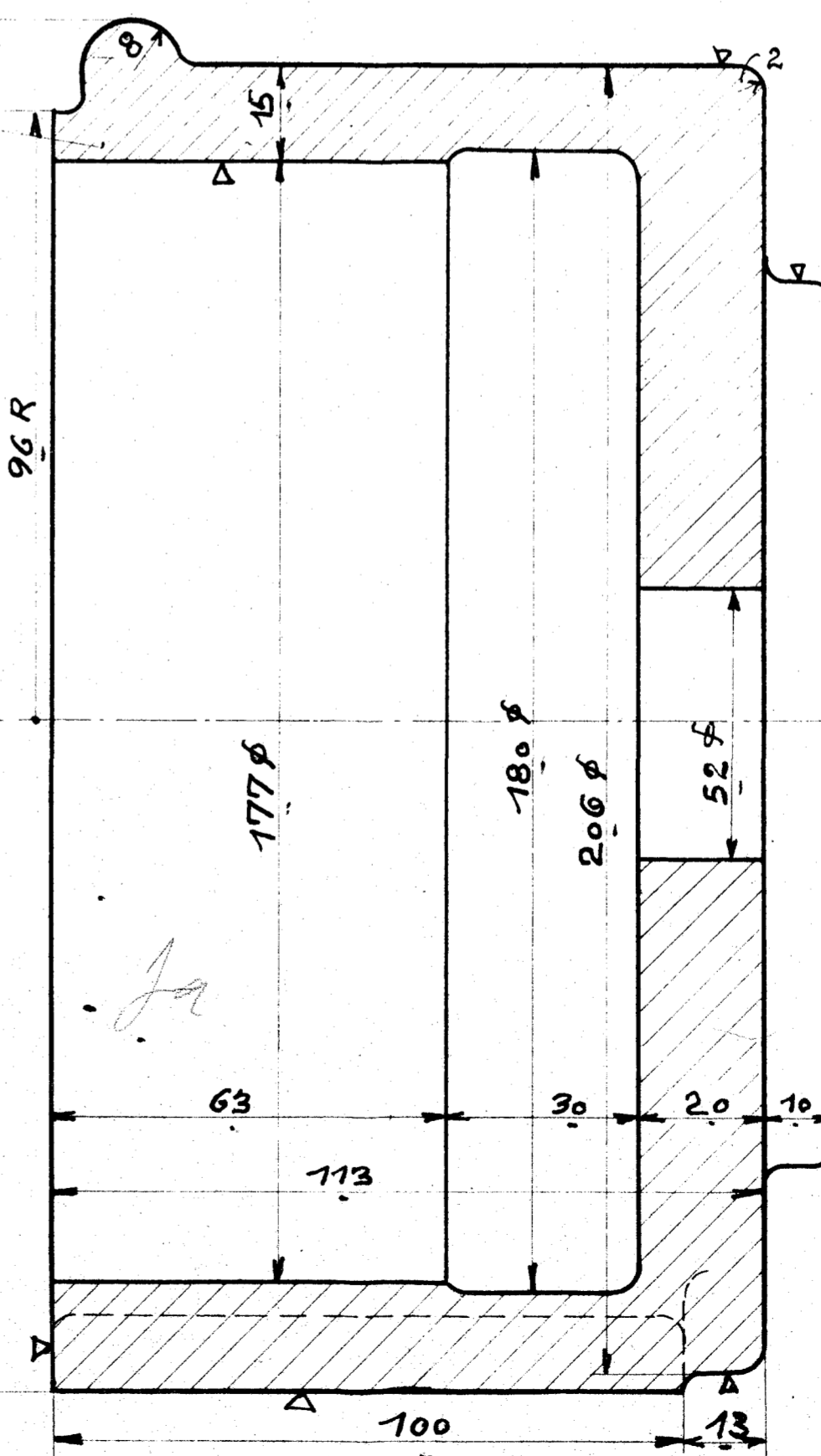
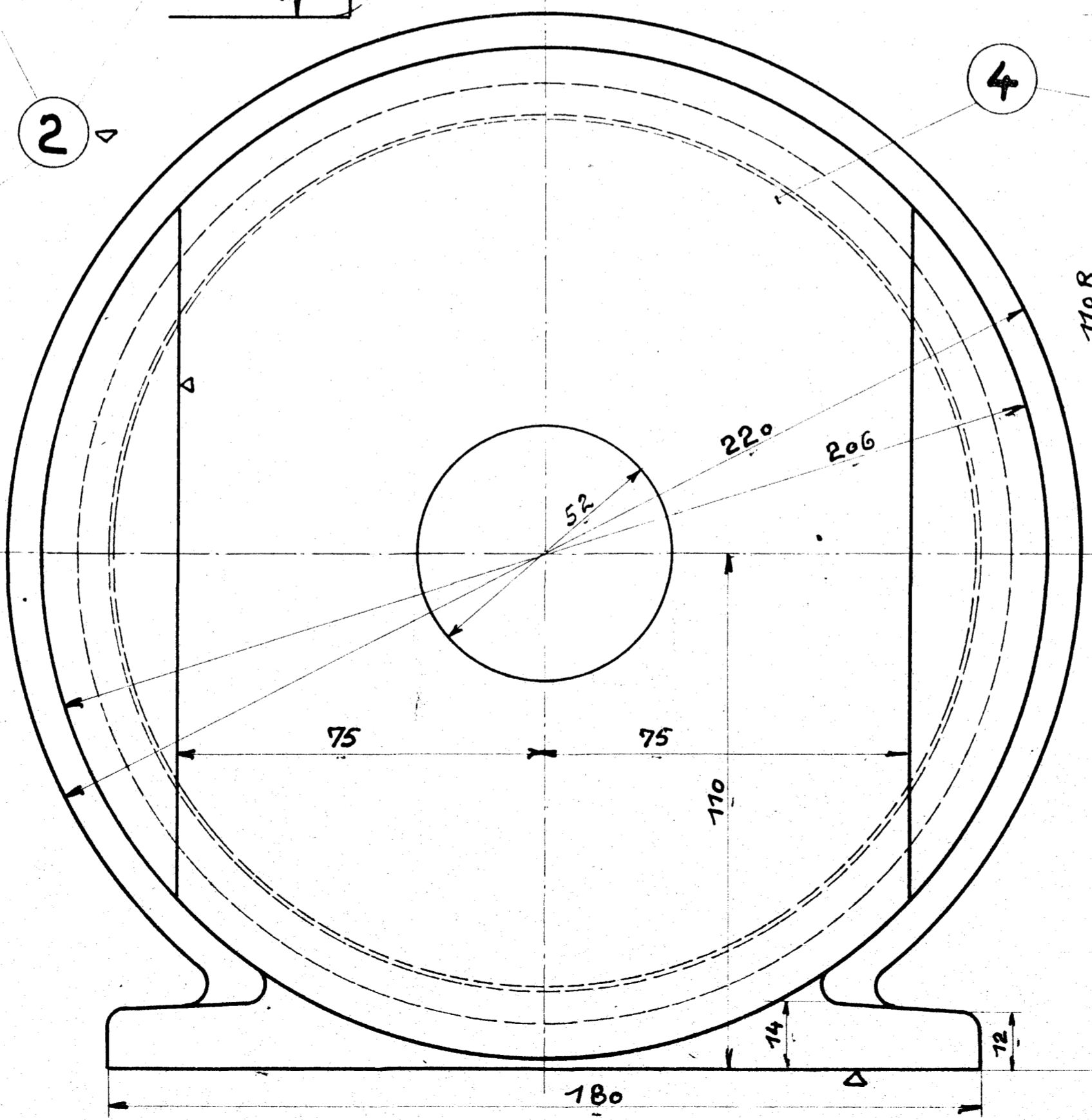
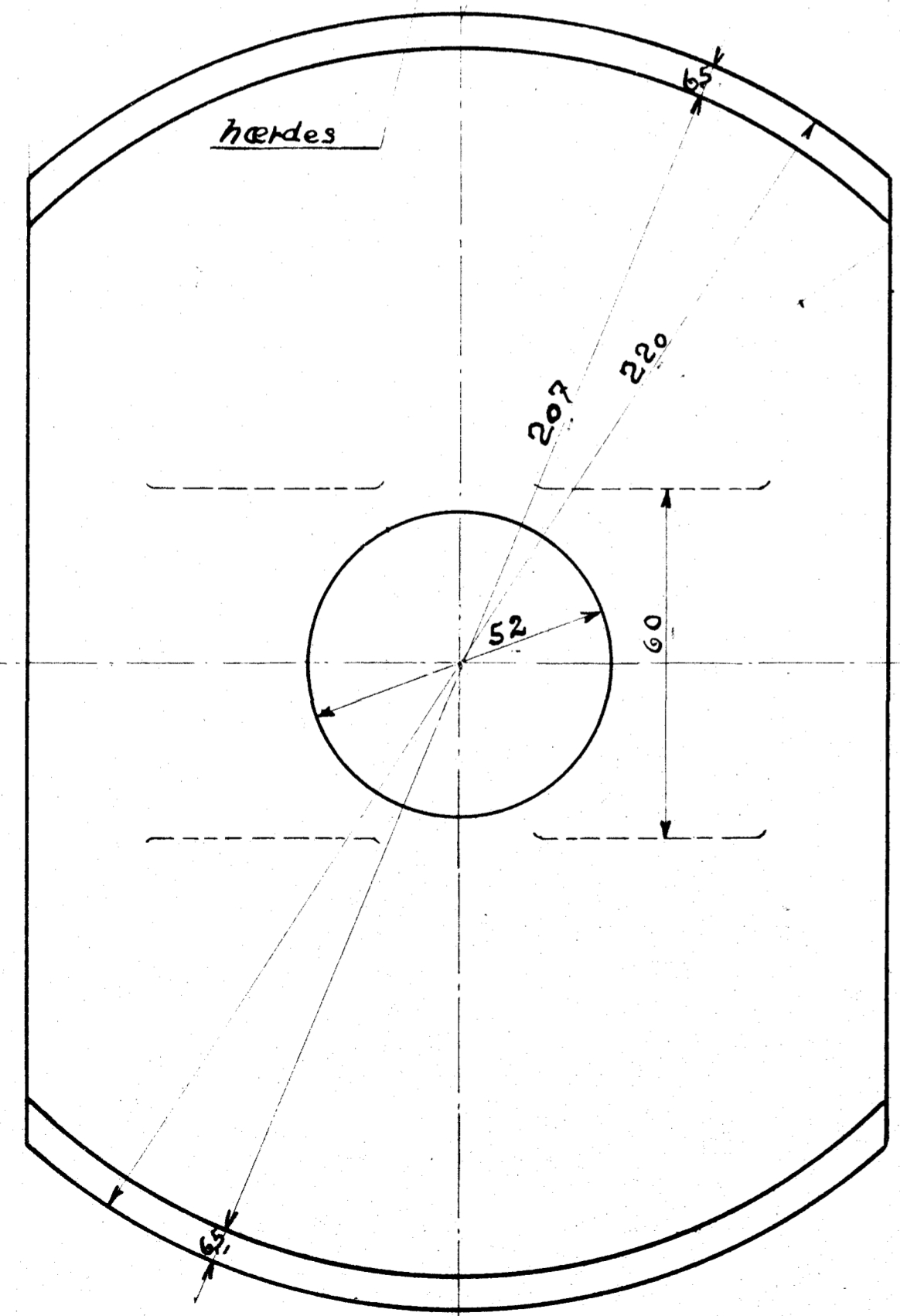
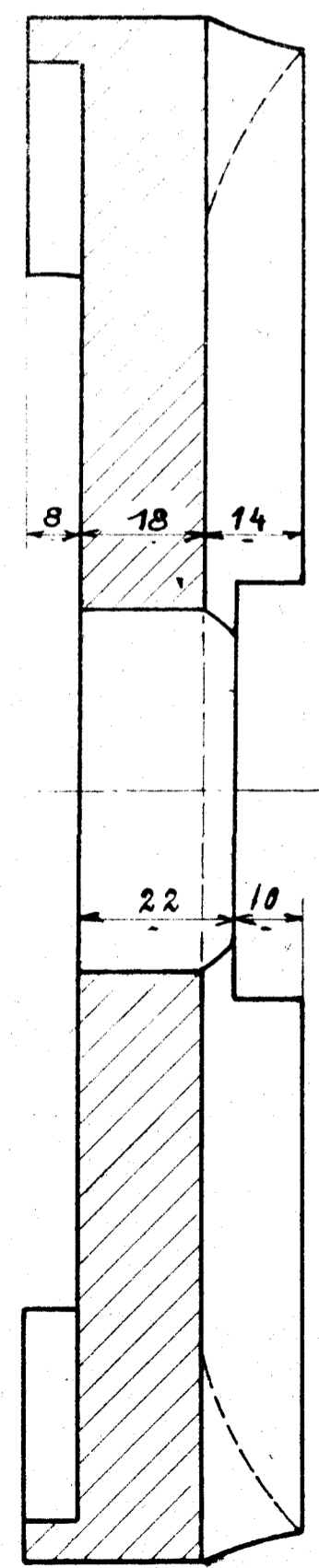

1/2 Bolt

Q.74 b

<b>Dele til Trækkrog</b>	
Diesel-elekt. 420 tk Motorloko. 1. B. 2	
EL	Sr. 10
18-9-28	1:1 106 L-155.

D. S. B.